



**Rasti**



**GigaBox**  
Construcción  
Guía de Armado

**4 EN 1\***

## Armado Casa quinta



Fig. | 1  
Base vista superior

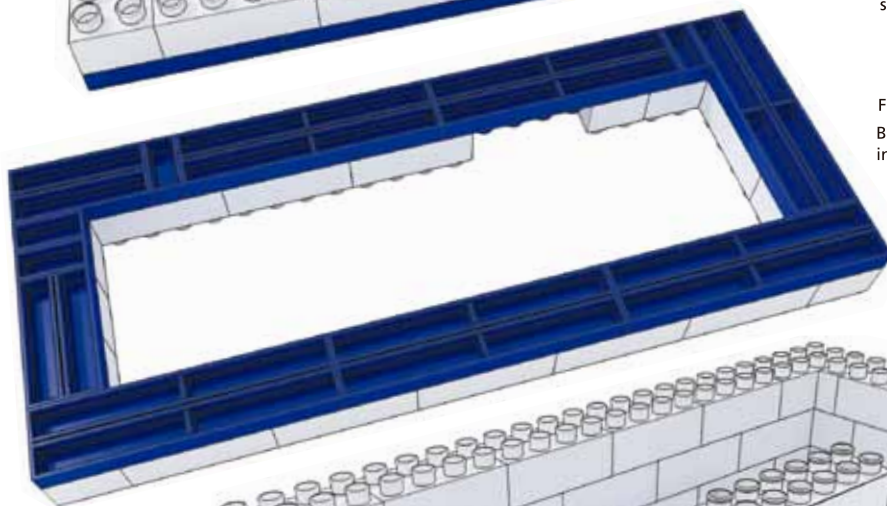

Fig. | 2  
Base vista inferior



Fig. | 3  
Montado primeras tres hiladas de ladrillos vista frontal

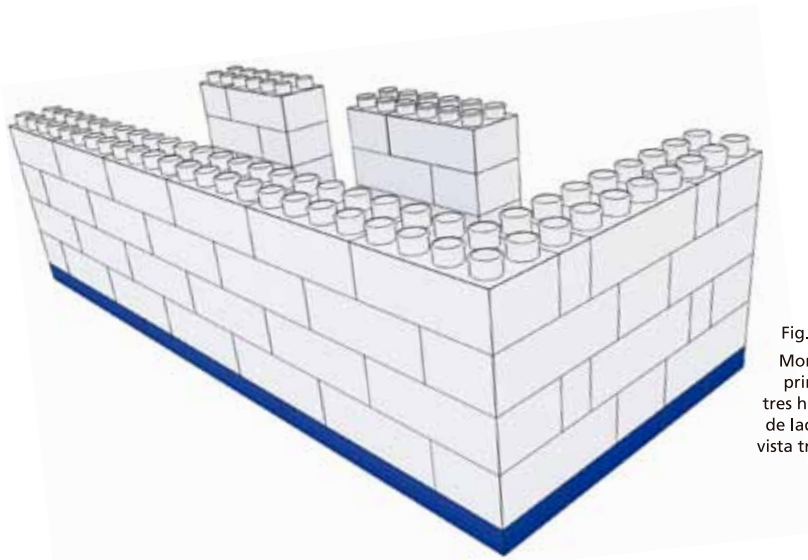

Fig. | 4  
Montado  
primeras  
tres hiladas  
de ladrillos  
vista trasera

Fig. | 5  
Montado  
de ventanas  
(montar los  
vidrios antes  
de colocar  
las ventanas)

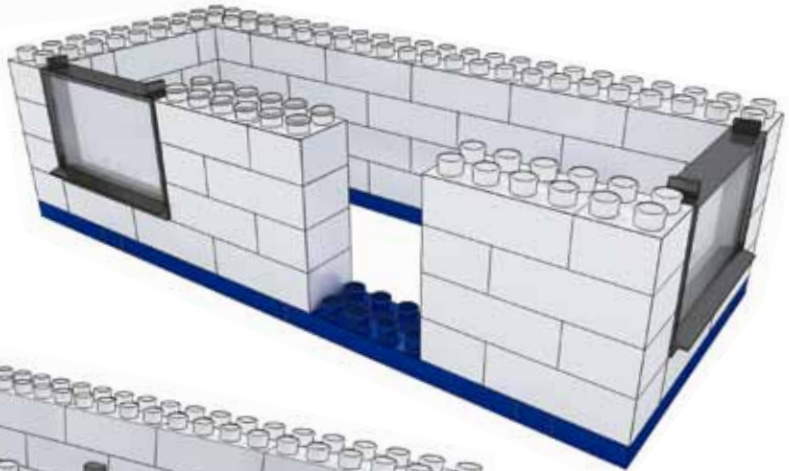

Fig. | 6  
Montado de puerta  
y colocación  
de una hilada más  
vista frontal

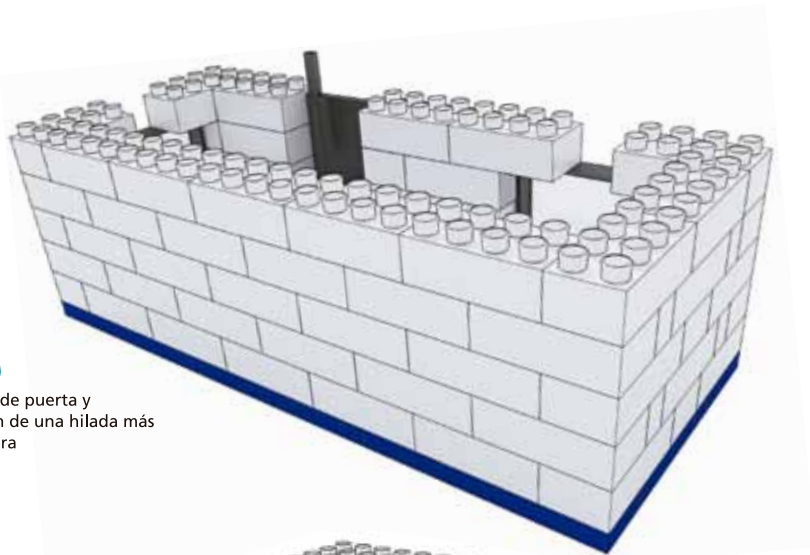

Fig. | 7  
Montado de puerta y  
colocación de una hilada más  
vista trasera



Fig. | 8  
Ultima hilada  
de la parte inferior  
de la casa  
vista frontal

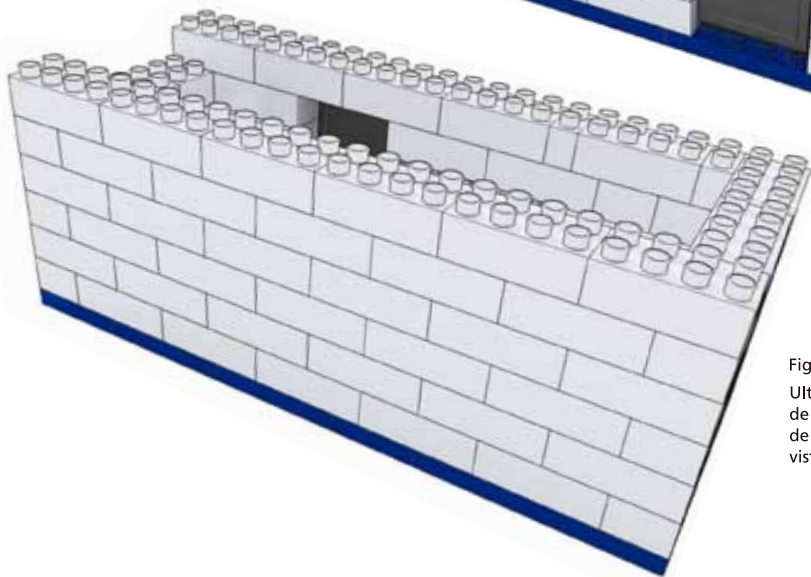

Fig. | 9  
Ultima hilada  
de la parte inferior  
de la casa  
vista trasera





Fig. | 10  
Detalle de soporte de balcón



Fig. | 11  
Pared superior 01

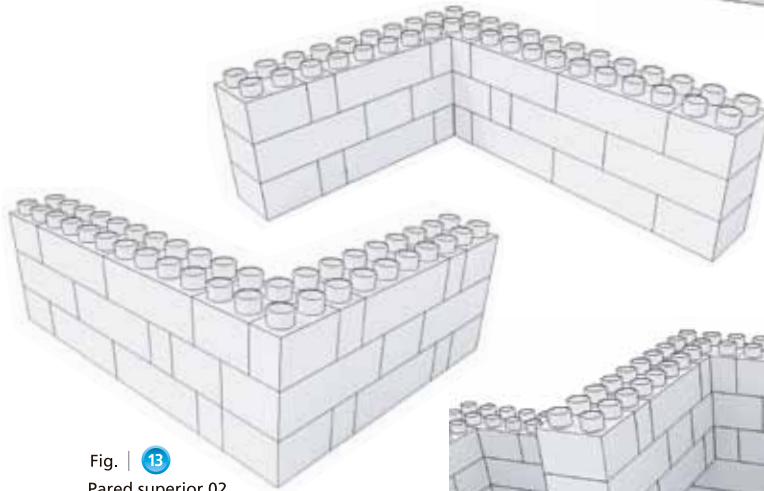

Fig. | 12  
Pared superior 02  
vista frontal

Fig. | 13  
Pared superior 02  
vista trasera



Fig. | 14  
Montado  
pared superior 02



Fig. | 15  
Balcón vista superior



Fig. | 17  
Montado balcón



Fig. | 16  
Balcón vista inferior



Fig. | 18  
Montado ventanas  
parte superior

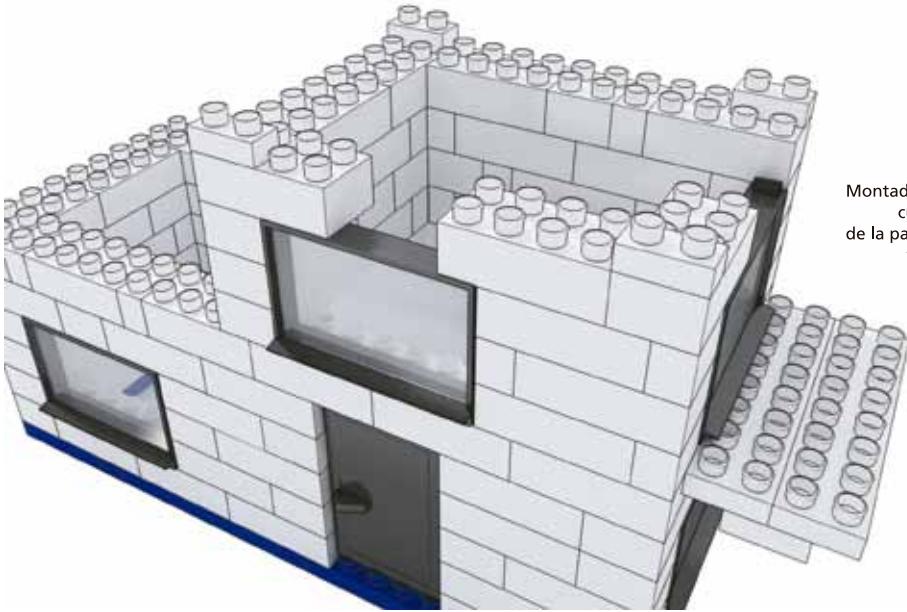

Fig. | 19  
 Montado parcial de  
 cuarta hilada  
 de la parte superior  
 vista frontal

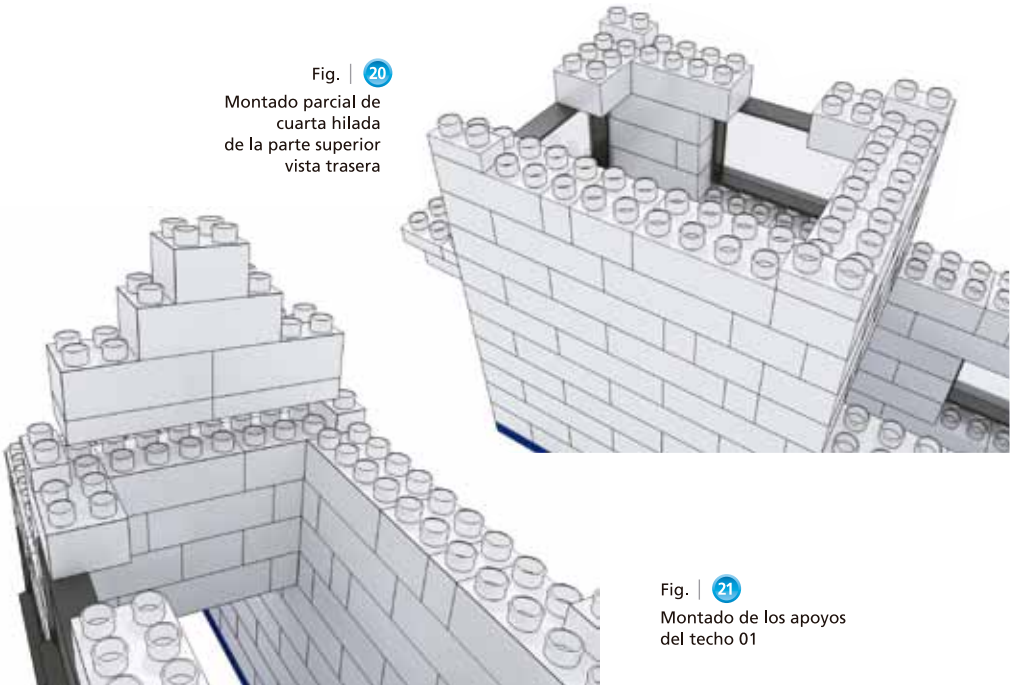

Fig. | 20  
 Montado parcial de  
 cuarta hilada  
 de la parte superior  
 vista trasera

Fig. | 21  
 Montado de los apoyos  
 del techo 01



Fig. | 22  
Montado de  
los apoyos  
del techo 02



Fig. | 23  
Cierre de la cuarta hilada  
vista frontal

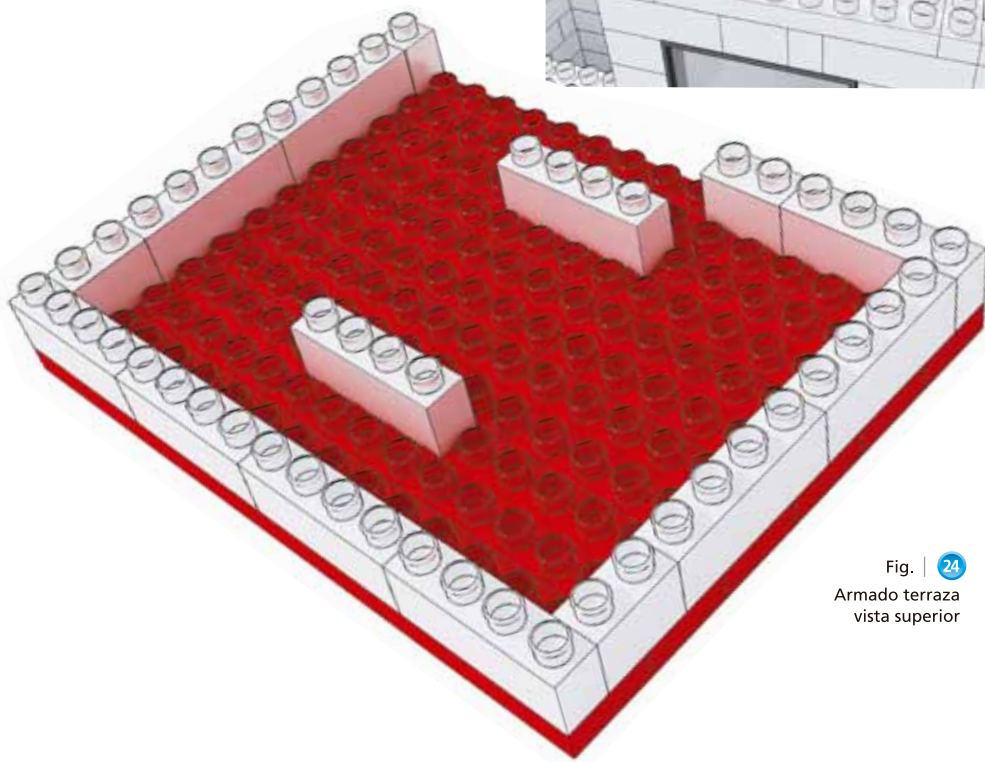

Fig. | 24  
Armado terraza  
vista superior



Fig. | 25  
Armado terraza  
vista inferior

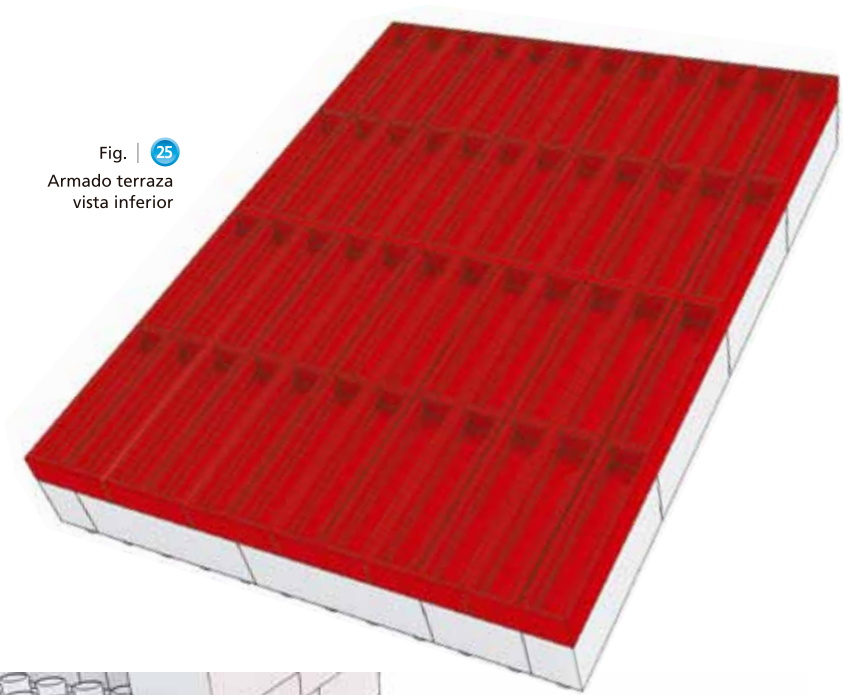
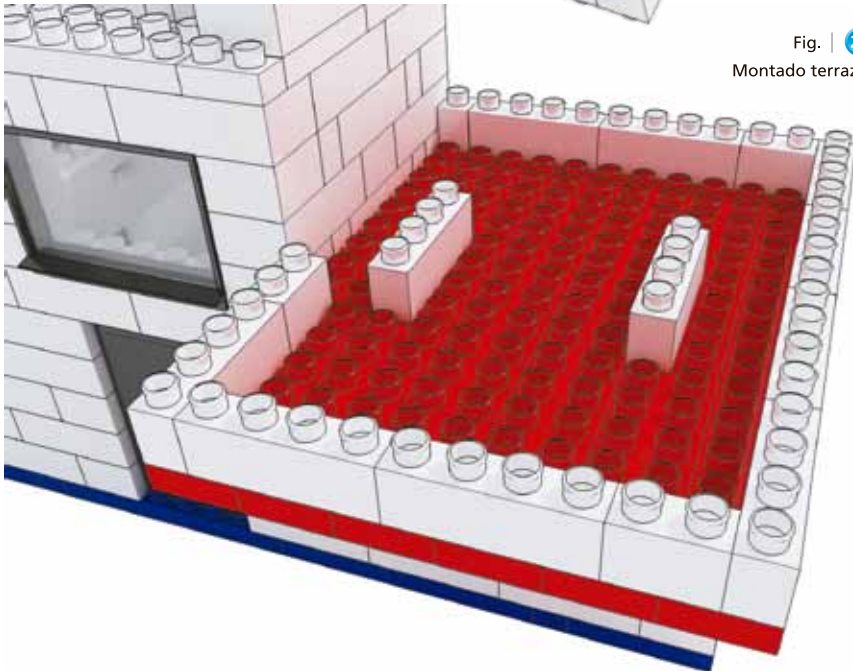

Fig. | 26  
Montado terraza



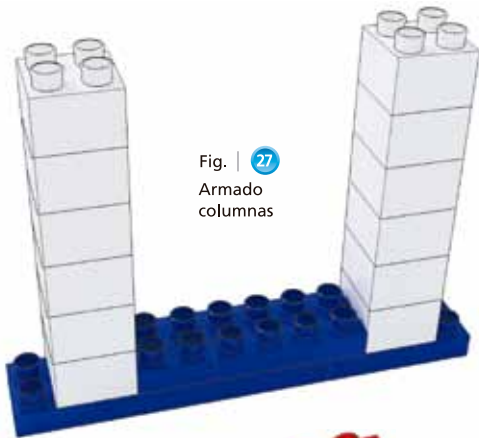

Fig. | 27  
Armado columnas

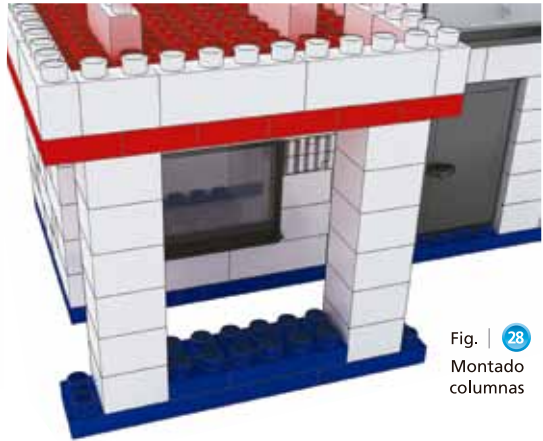

Fig. | 28  
Montado columnas

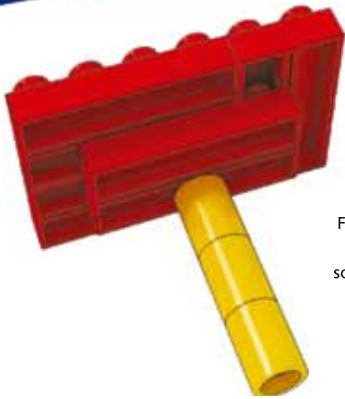

Fig. | 29  
Armado sombrilla

Fig. | 30  
Montado sombrilla

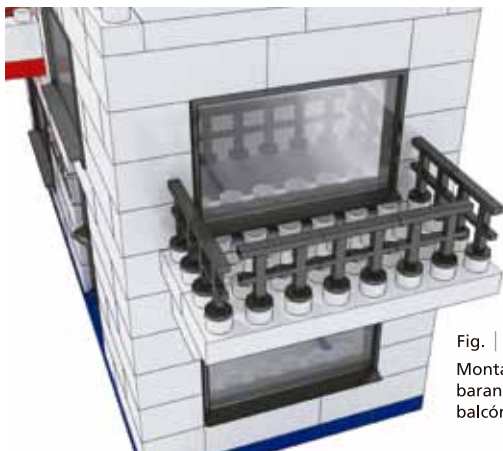

Fig. | 31  
Montado barandas balcón

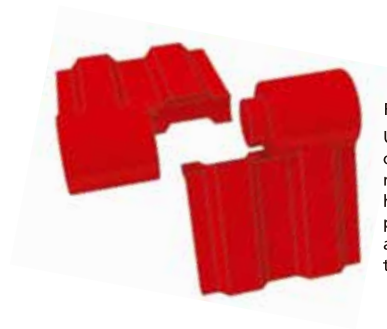

Fig. | 32  
Unión de caballete macho y hembra para armado de techo



Fig. | 33  
Unión  
de pares de  
caballetes  
mediante tejas  
que los traben entre sí

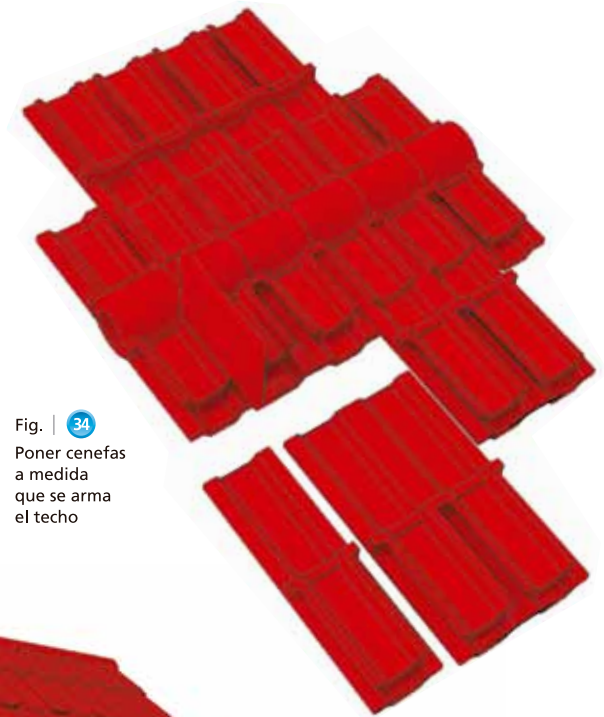

Fig. | 34  
Poner cenefas  
a medida  
que se arma  
el techo



Fig. | 35  
Modelo terminado

## Armado Arco del Triunfo

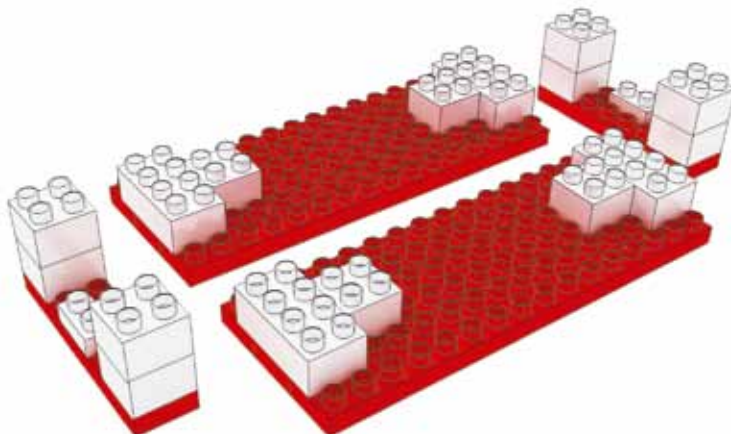

Fig. | 1  
Despiece base

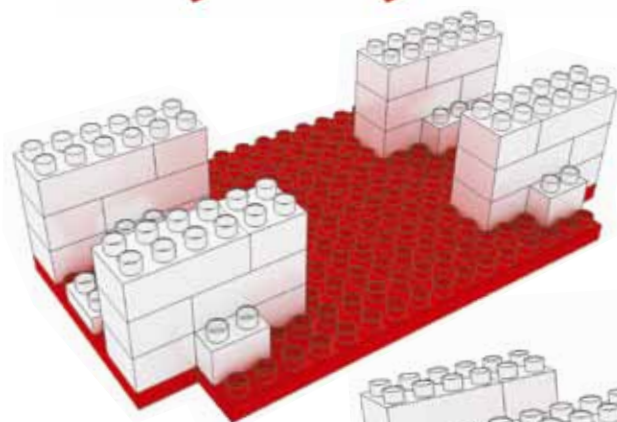

Fig. | 2  
Unión de la base  
mediante dos hiladas  
de ladrillos

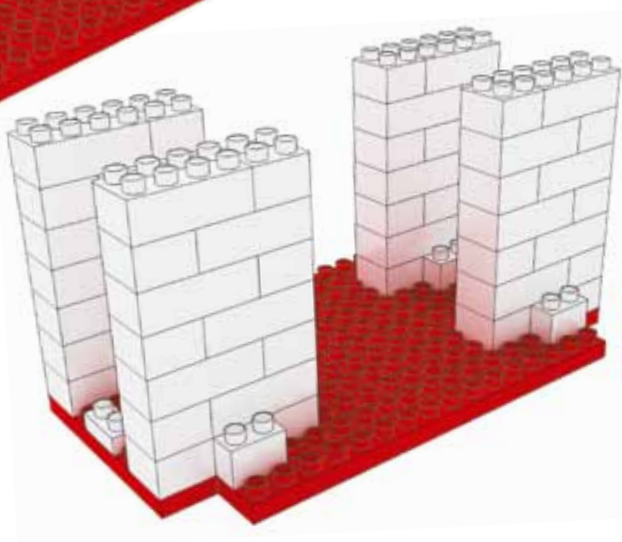

Fig. | 3  
Montado  
cuatro hiladas



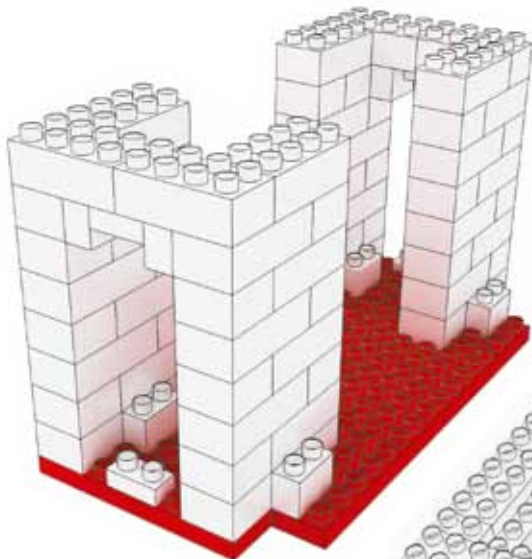

Fig. | 4  
Armado  
arcos laterales

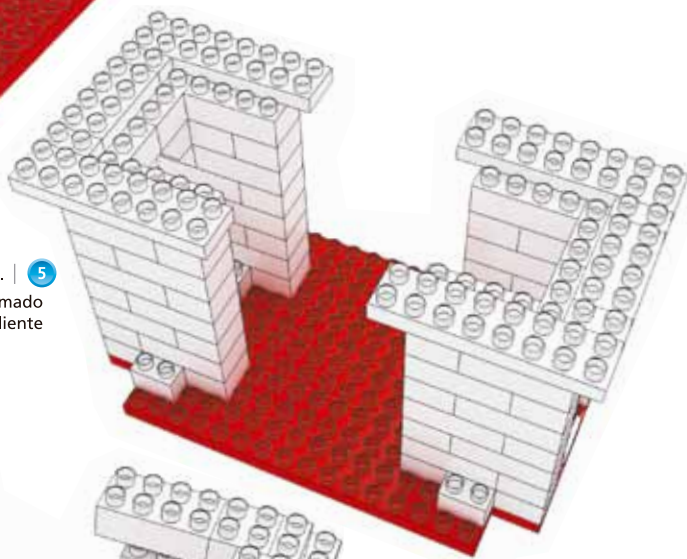

Fig. | 5  
Armado  
primer saliente

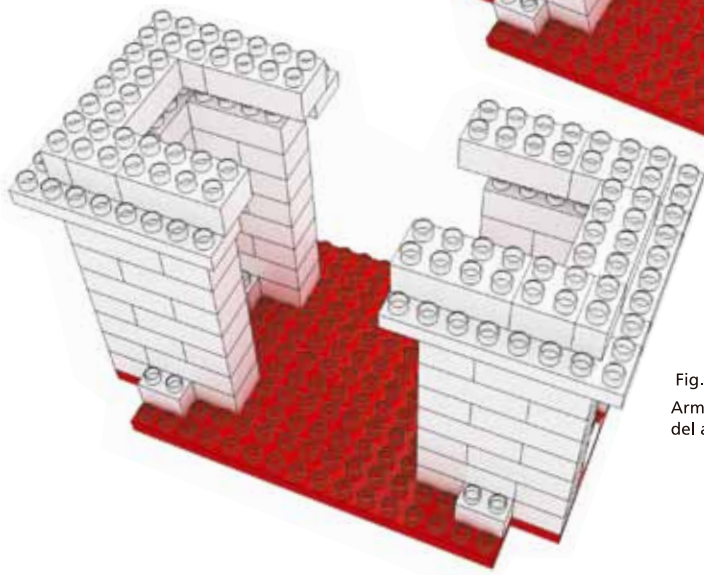

Fig. | 6  
Armado base  
del arco superior

Fig. | 7  
Armado parte media  
del arco superior

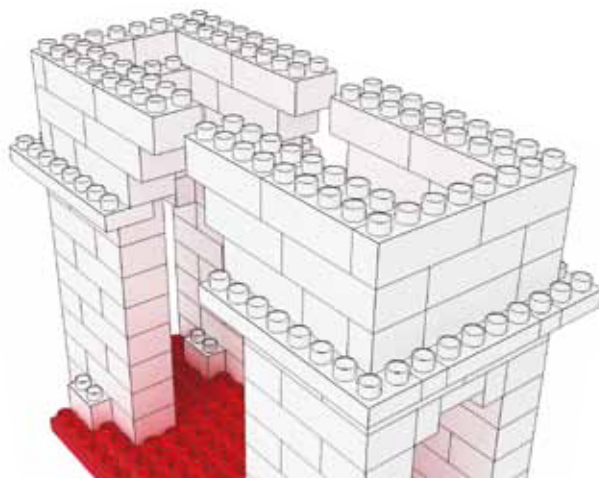

Fig. | 8  
Arco superior terminado

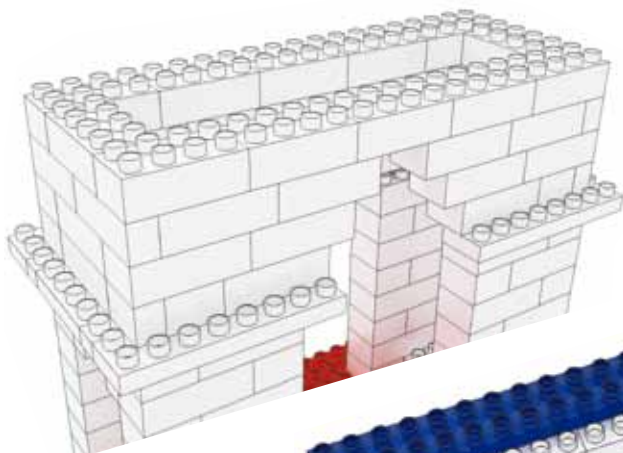
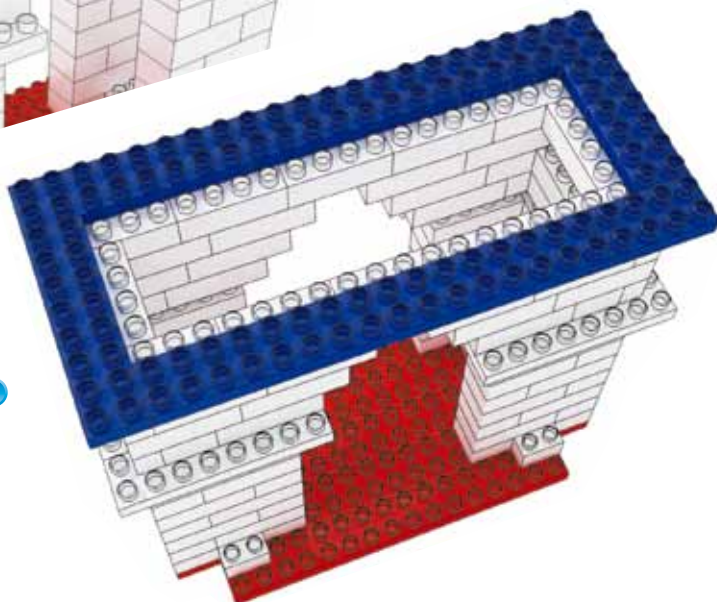

Fig. | 9  
Armado  
segunda saliente



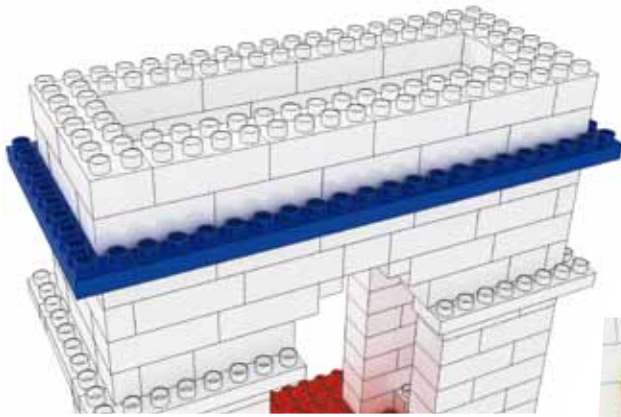

Fig. | 10  
Armado parte superior  
del arco

Fig. | 11  
Decoraciones

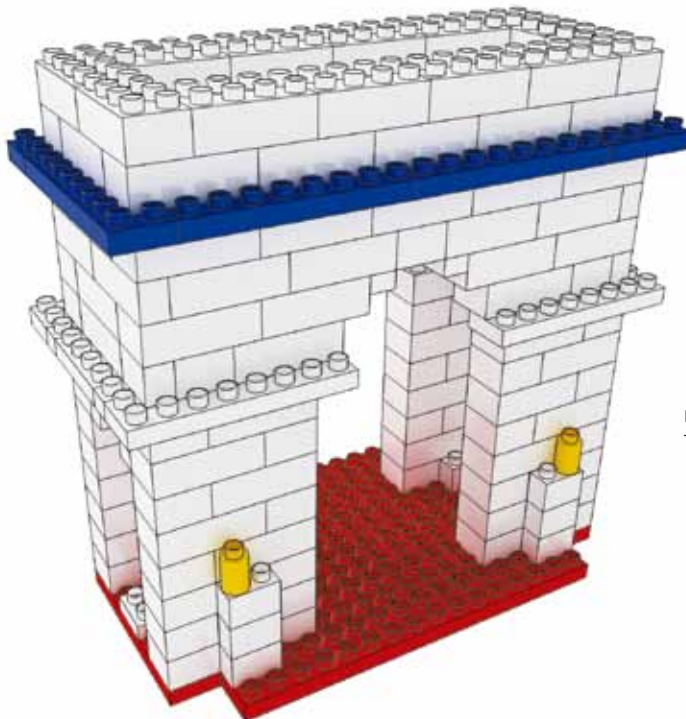
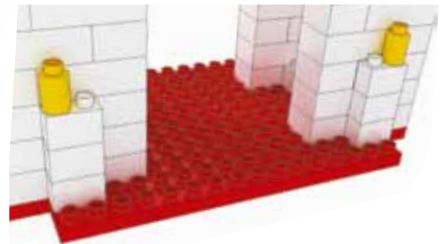

Fig. | 12  
Modelo  
terminado

## Armado Torre de control

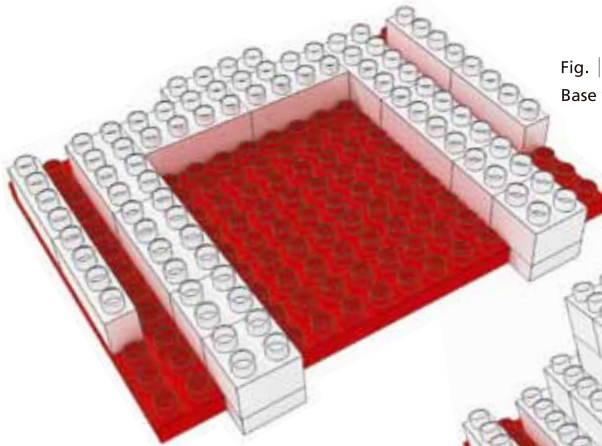

Fig. | 1  
Base vista superior

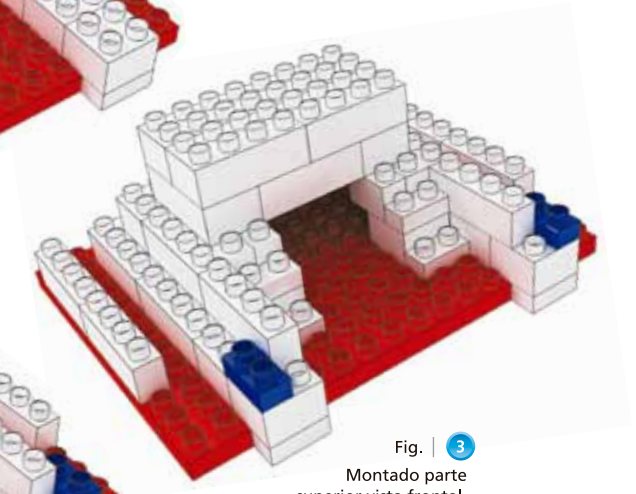

Fig. | 3  
Montado parte superior vista frontal

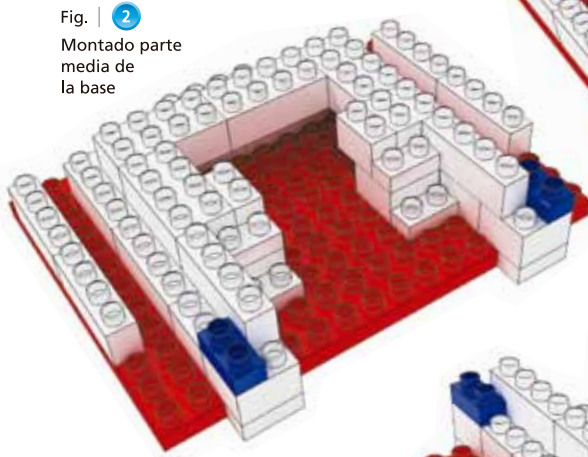

Fig. | 2  
Montado parte media de la base

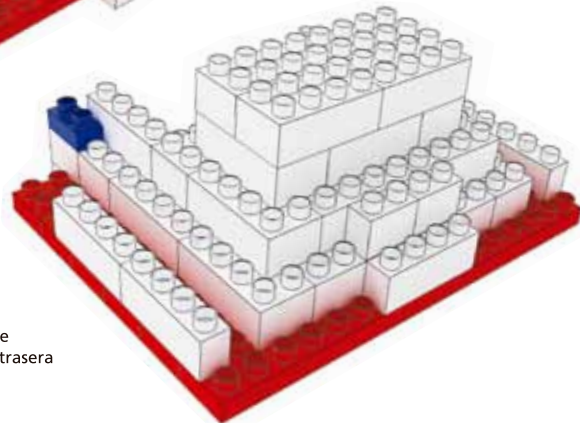

Fig. | 4  
Montado parte superior vista trasera



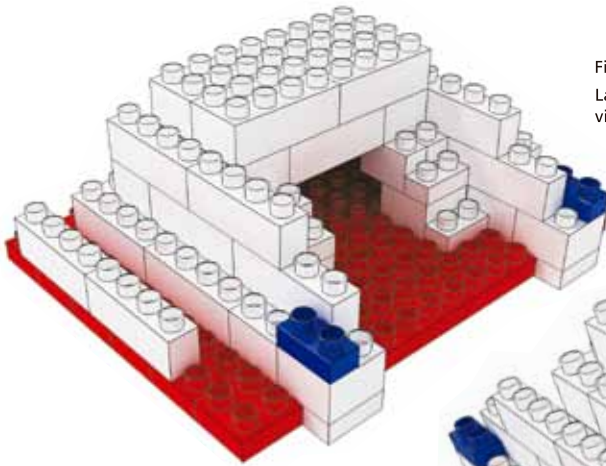

Fig. | 5  
Laterales de refuerzo  
vista frontal

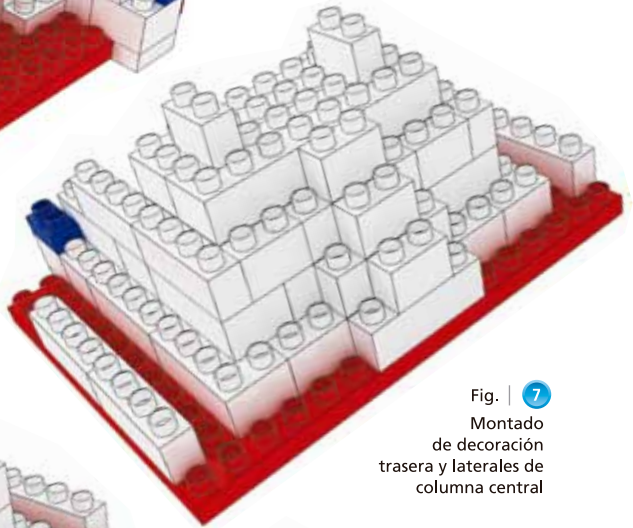

Fig. | 7  
Montado  
de decoración  
trasera y laterales de  
columna central

Fig. | 6  
Laterales de refuerzo  
vista trasera

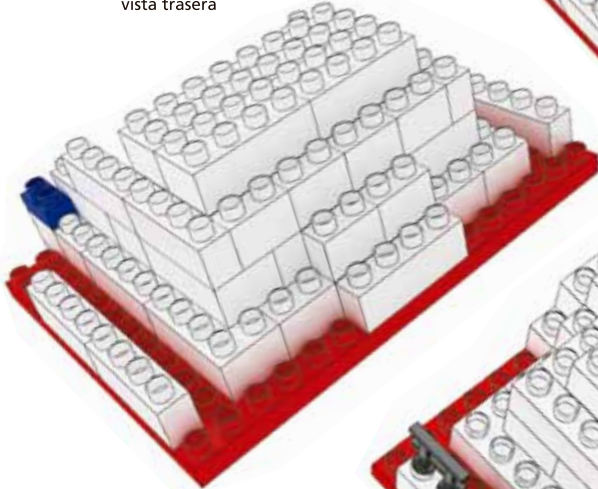
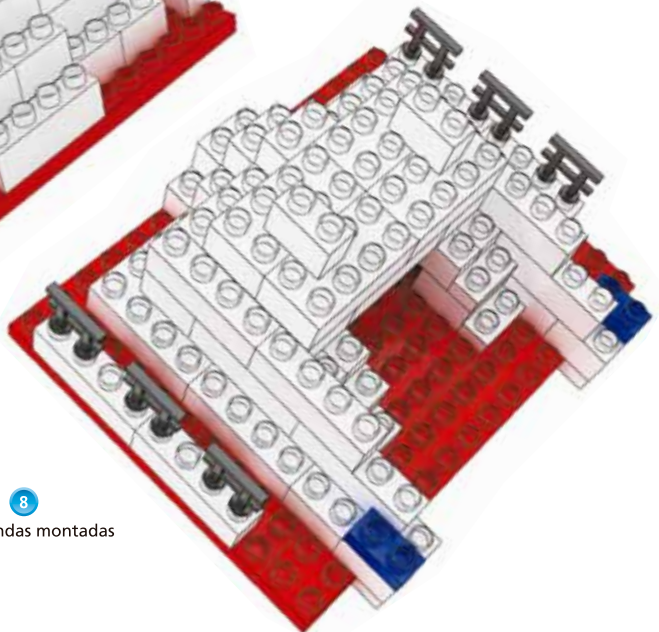

Fig. | 8  
Barandas montadas



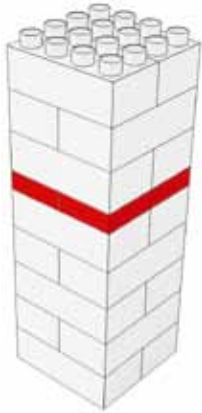

Fig. | 9  
Armado  
parte inferior  
de columna  
central

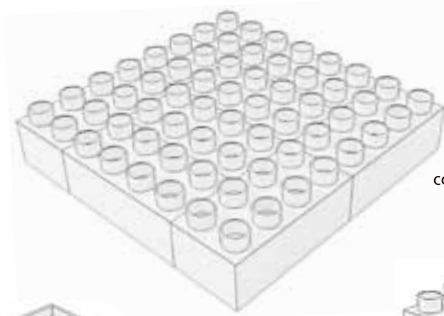

Fig. | 10  
Armado  
plataforma  
media de la  
columna central  
vista superior

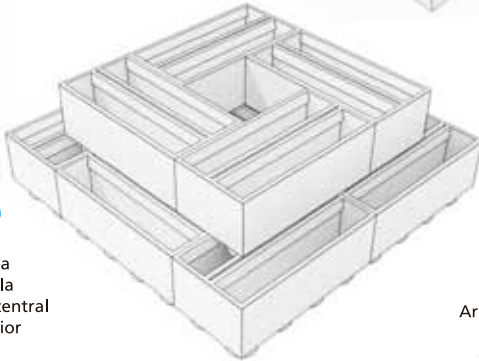

Fig. | 11  
Armado  
plataforma  
media de la  
columna central  
vista inferior

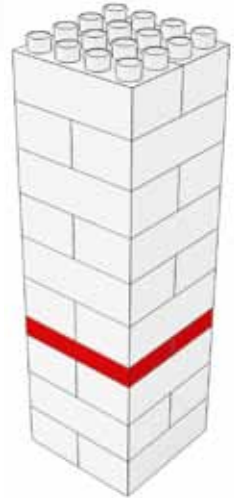

Fig. | 12  
Armado parte  
superior  
de columna  
central

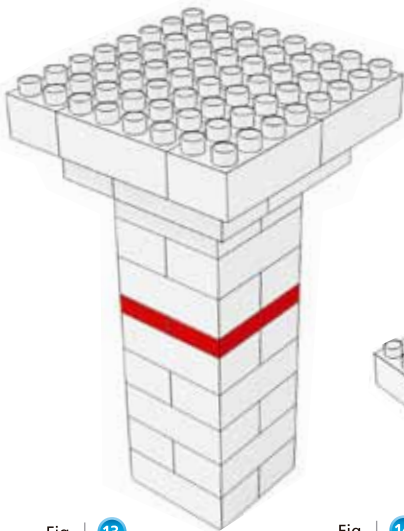

Fig. | 13  
Montado  
parte inferior con  
plataforma media

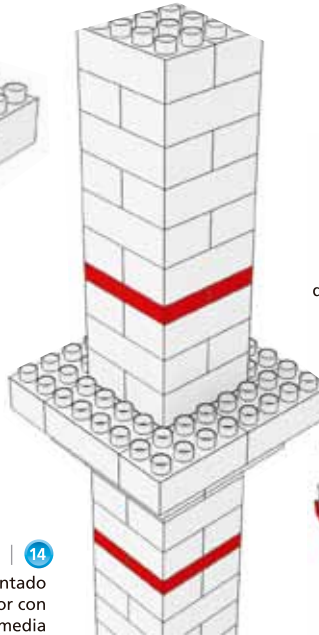

Fig. | 14  
Montado  
parte superior con  
plataforma media

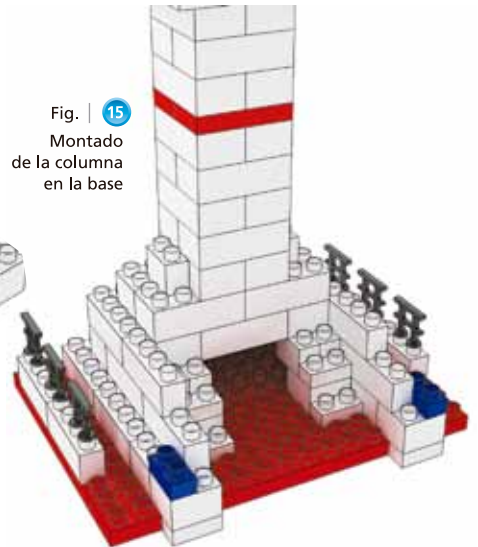

Fig. | 15  
Montado  
de la columna  
en la base

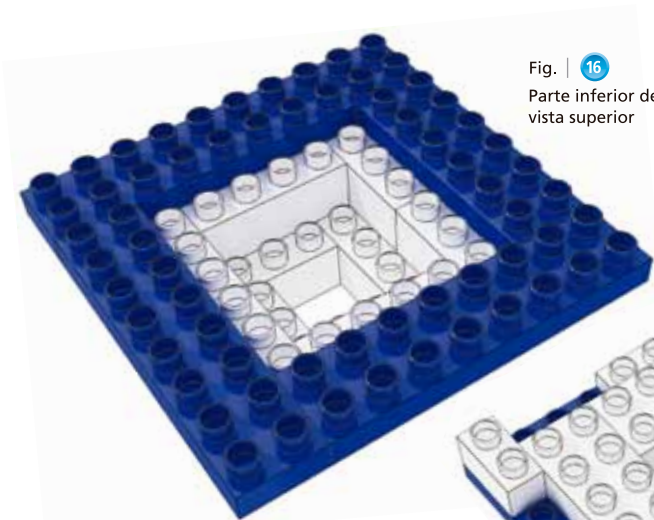

Fig. | 16  
Parte inferior de la cabina  
vista superior

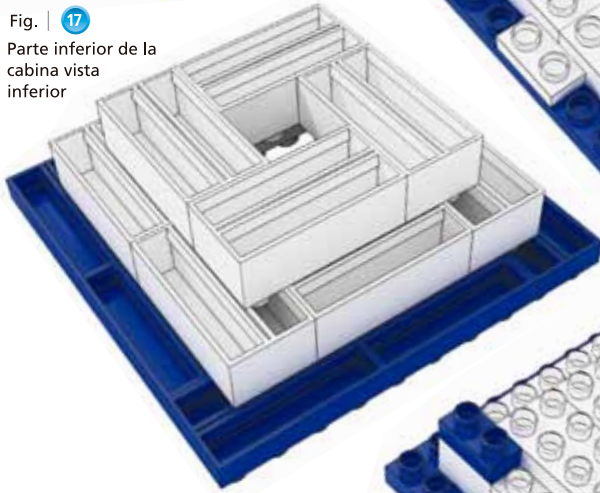

Fig. | 17  
Parte inferior de la  
cabina vista  
inferior

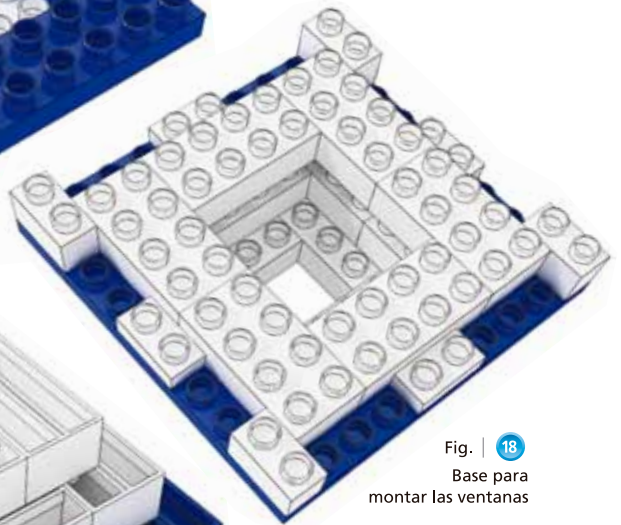

Fig. | 18  
Base para  
montar las  
ventanas

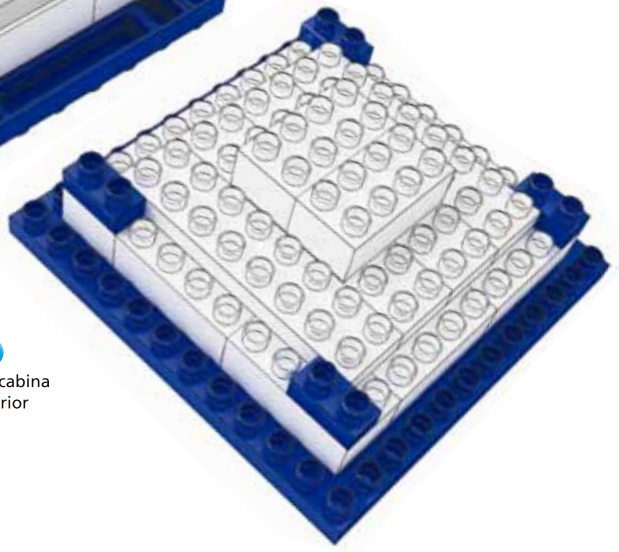

Fig. | 19  
Techo de cabina  
vista superior



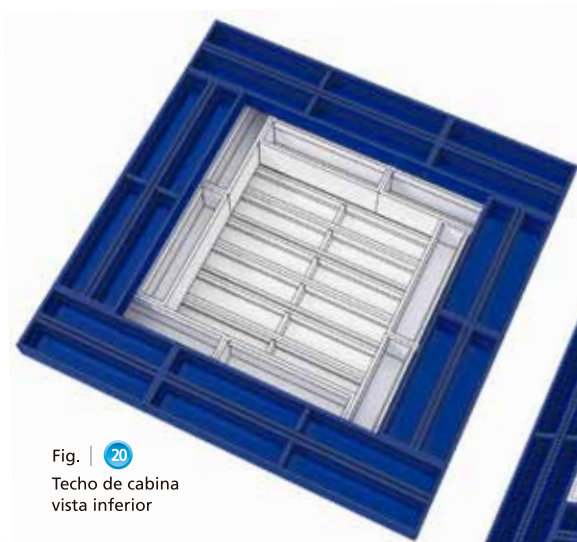

Fig. | 20  
Techo de cabina  
vista inferior

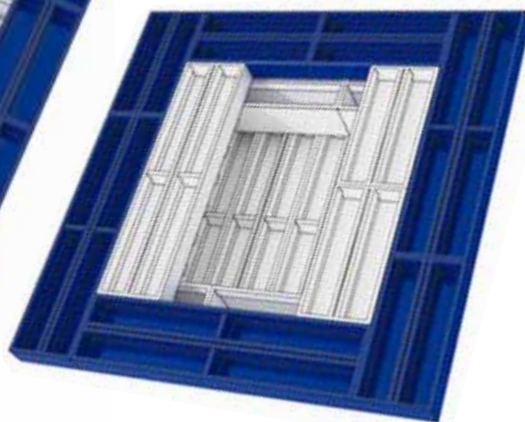

Fig. | 21  
Montado traba de ventanas



Fig. | 22  
Montado de  
columnas y ventanas

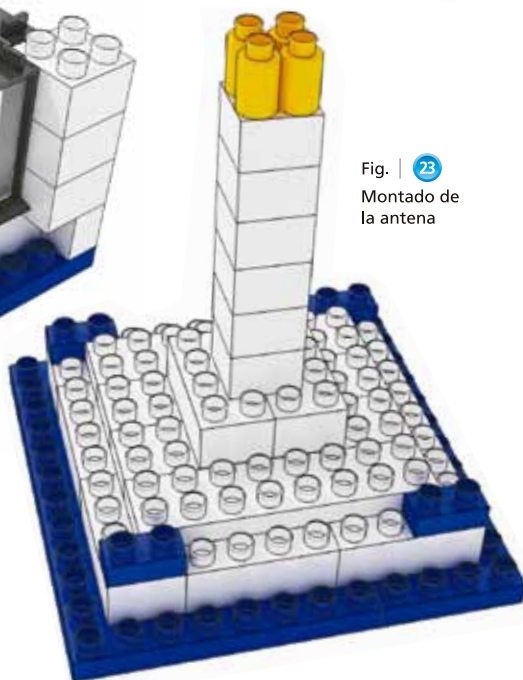

Fig. | 23  
Montado de  
la antena





Fig. | 24  
Montado de cabina  
sobre columna

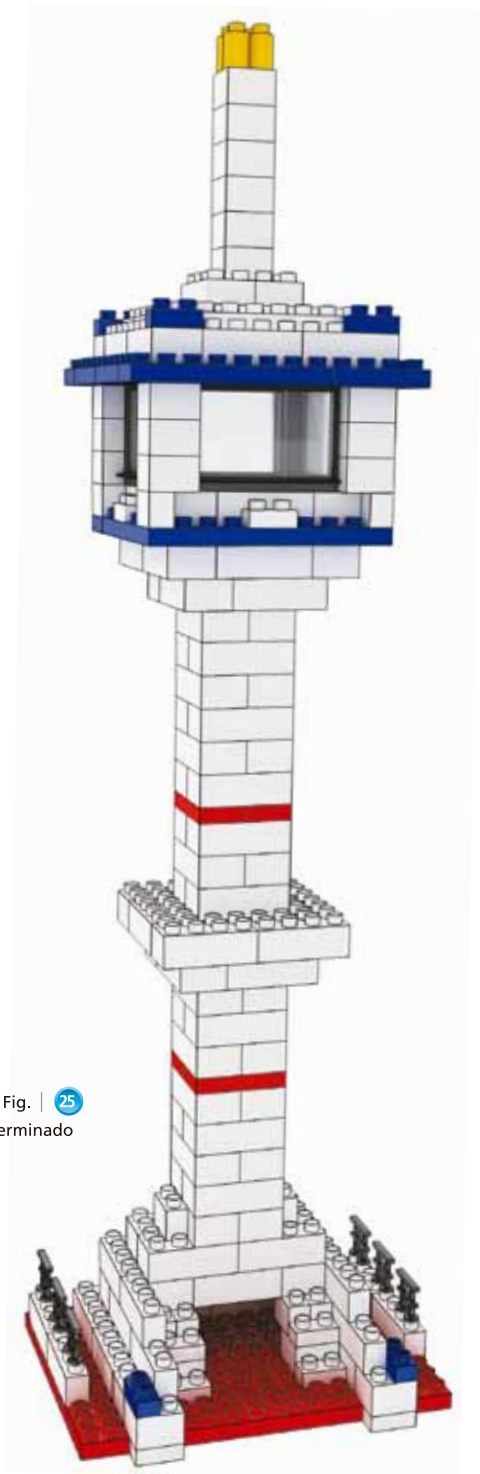

Fig. | 25  
Modelo terminado

Fig. | 1  
Despiece base

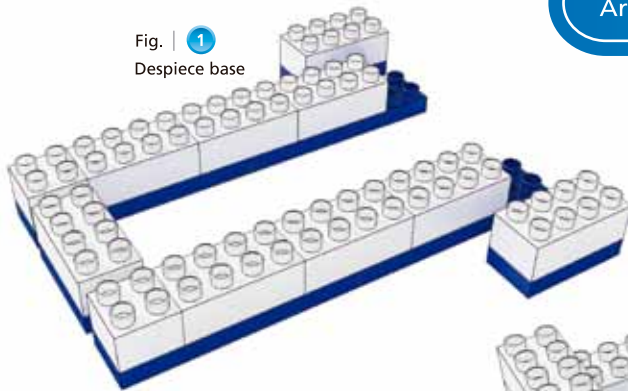

Fig. | 2  
Base unida con  
una hilada de ladrillos

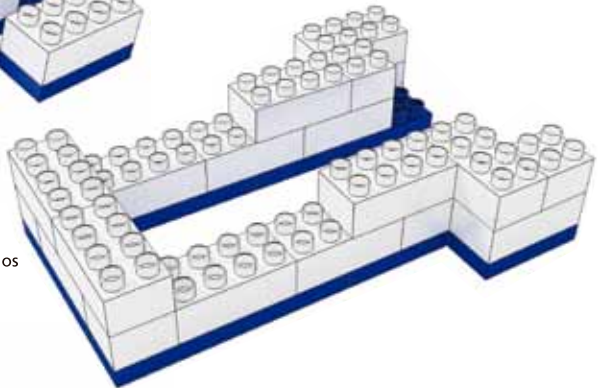

Fig. | 3  
Dos hileras  
de ladrillos  
mas colocadas

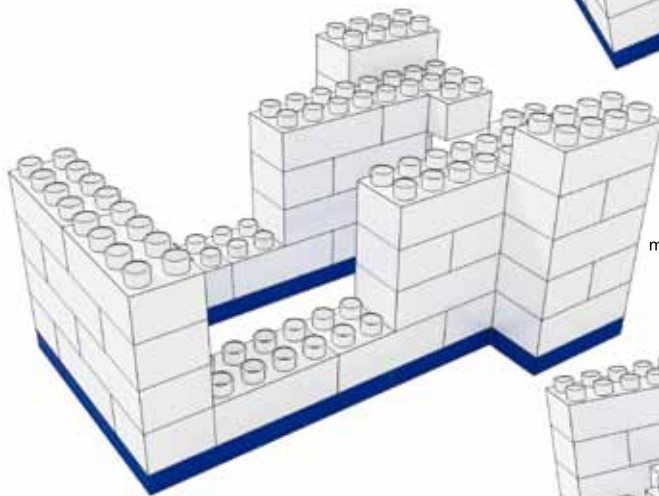

Fig. | 4  
Dos hileras de ladrillos  
mas colocadas otra vista

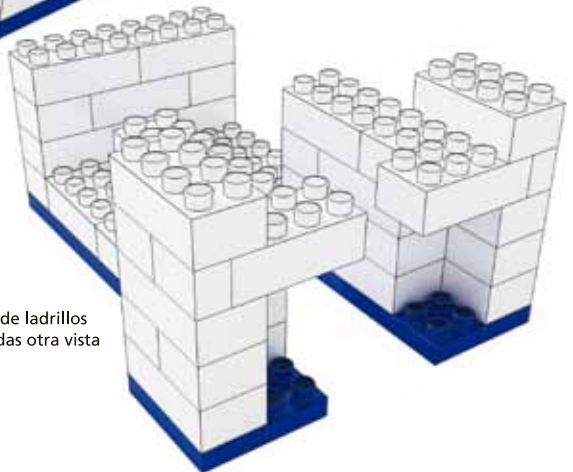

Fig. | 5  
Montado de ventanas

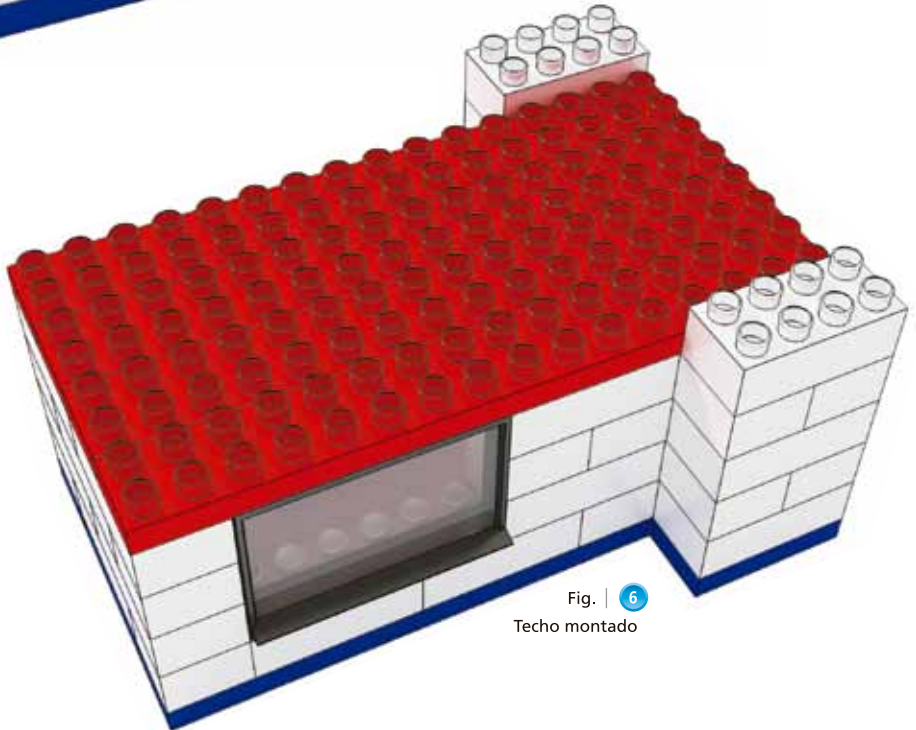
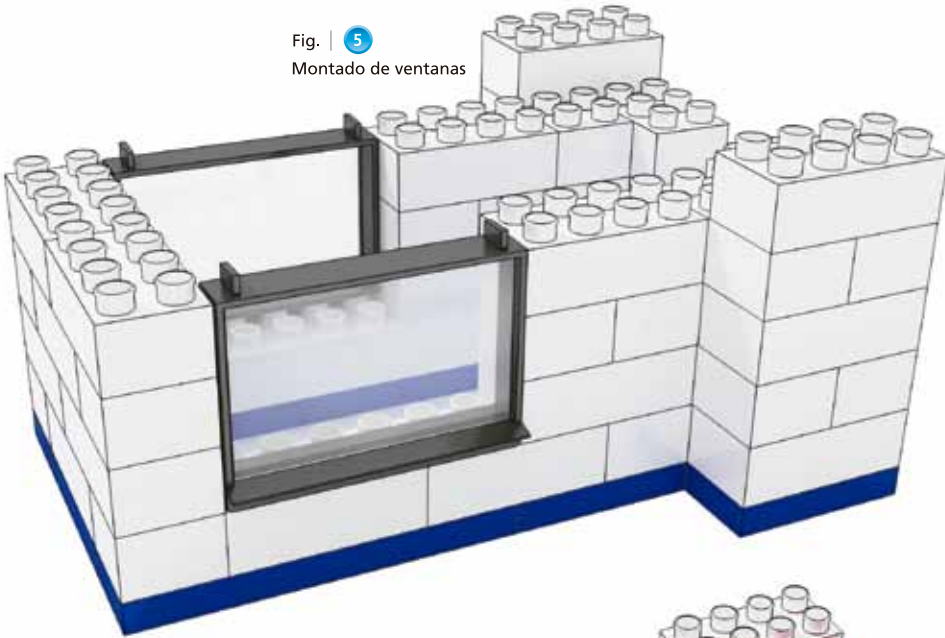

Fig. | 6  
Techo montado

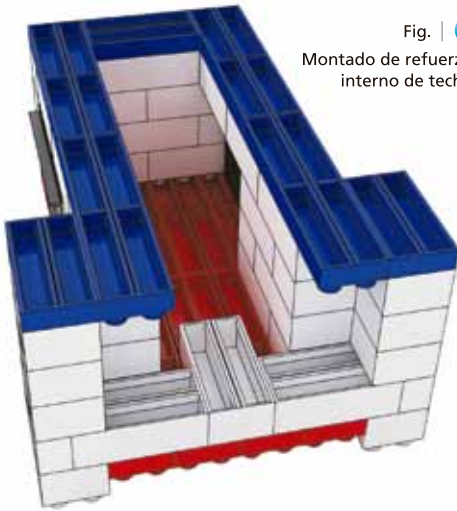

Fig. | 7  
Montado de refuerzo  
interno de techo

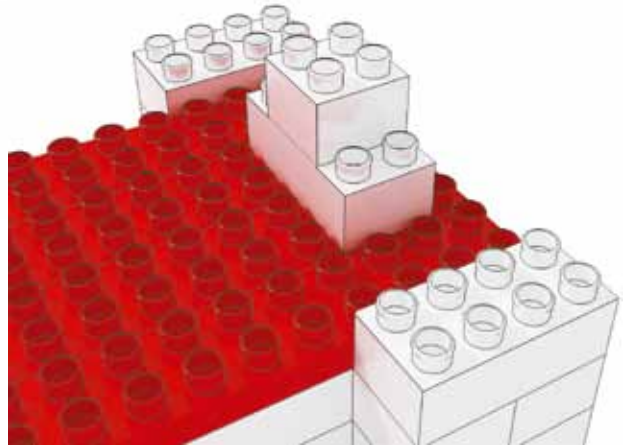

Fig. | 8  
Montado de apoyo  
de techo lateral

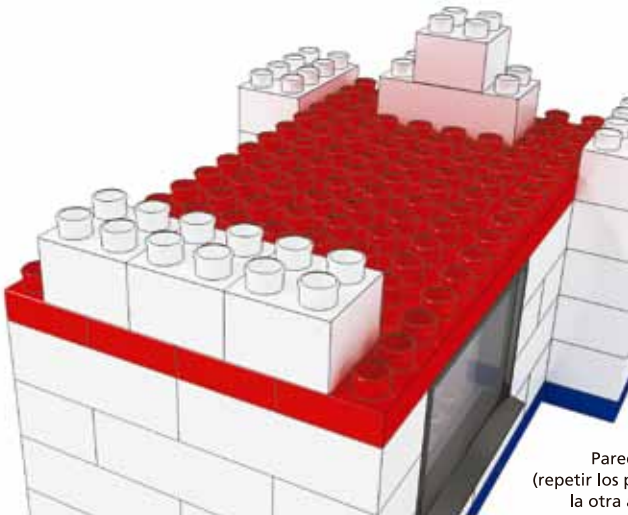

Fig. | 9  
Pared lateral montada  
(repetir los pasos 01 a 09 para  
la otra ala de la estación)



Fig. | 10

Apoyo de techo central  
vista inferior (construir dos)

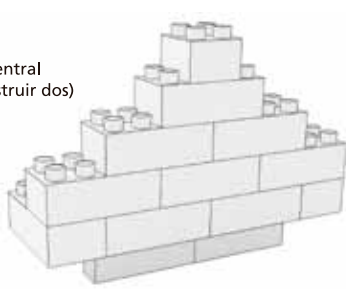

Fig. | 11

Apoyo de techo central  
vista exterior

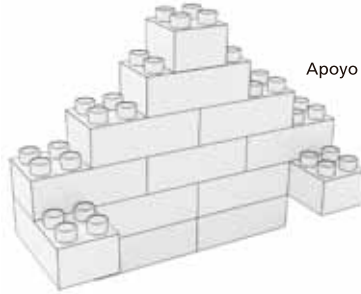

Fig. | 12

Montado de la  
unión de los dos  
apoyos de techo

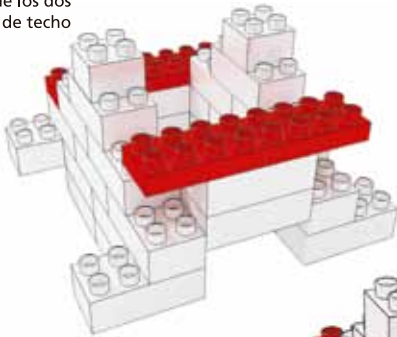

Fig. | 13

Montado de la  
unión de los dos  
apoyos de techo  
(pieza inferior)

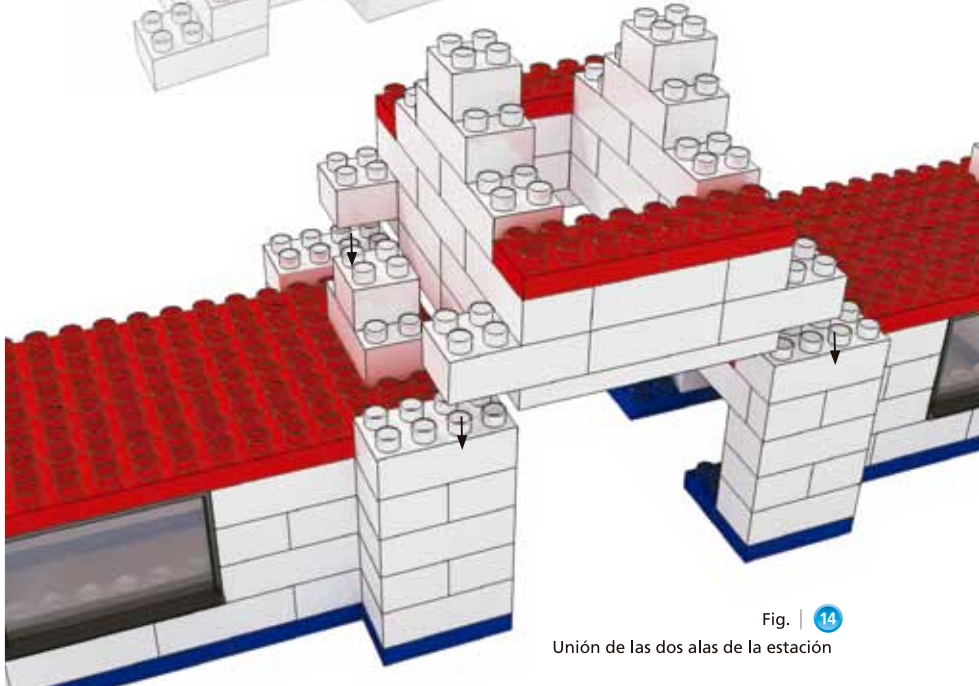
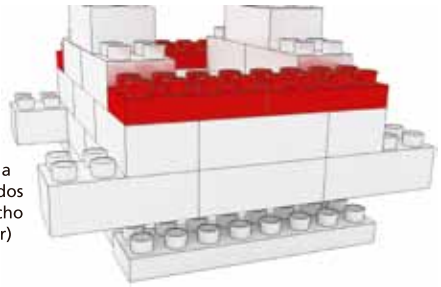

Fig. | 14

Unión de las dos alas de la estación

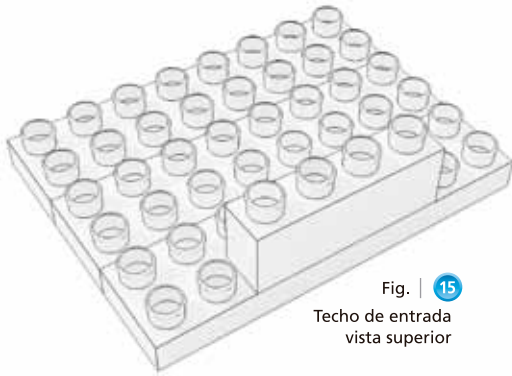

Fig. | 15  
Techo de entrada  
vista superior

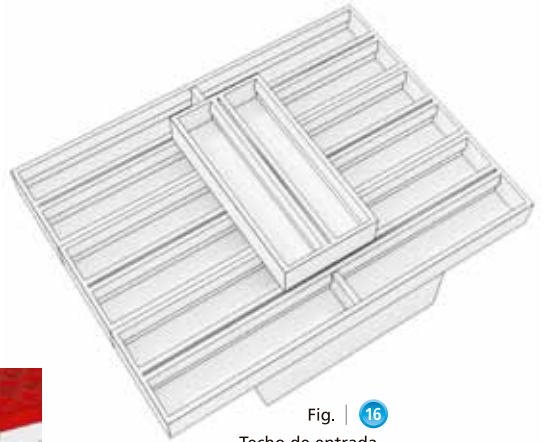

Fig. | 16  
Techo de entrada  
vista inferior

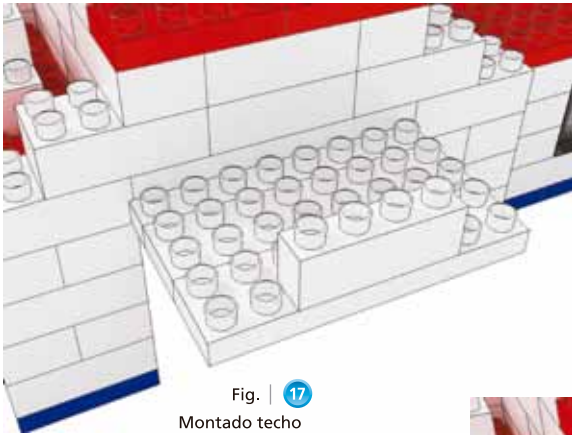

Fig. | 17  
Montado techo



Fig. | 18  
Montado tensores de techo

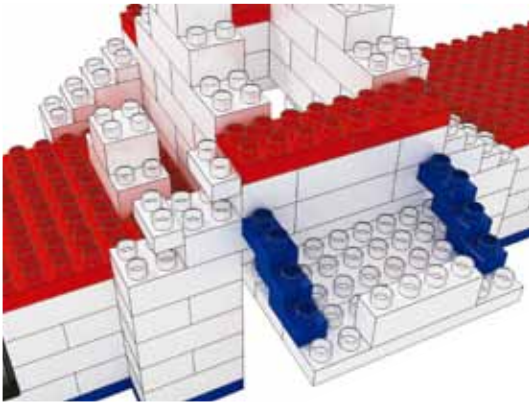

Fig. | 19  
Montado de piezas  
de decoración



Fig. | 20  
Barandas montadas

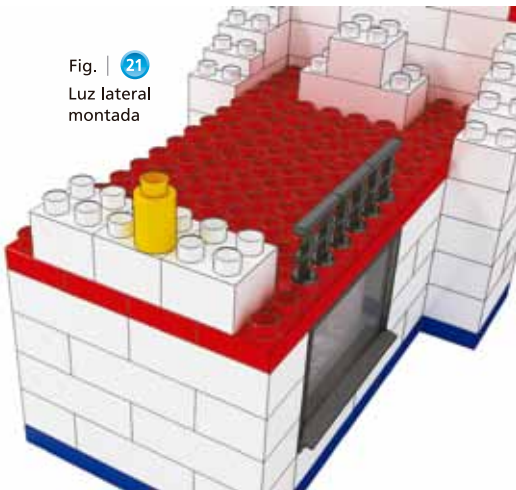

Fig. | 21  
Luz lateral  
montada



Fig. | 22  
Luces de techo  
montadas

Fig. | 23  
Techos de tejas vista superior



Fig. | 24  
Techos de tejas vista inferior



Fig. | 25  
Modelo terminado



# MotoBox

Rasti

CON  
MOTOR



Camión Minero



Dragster



Grúa Pluma

Camión Minero

# 600

piezas

3 EN 1\*



Helicóptero

Ultraviviano

Helicóptero

# 500

piezas



3 EN 1\*



Autoelevador



Cuatriciclo

# 300

piezas



Arenero

150

piezas



Dale Vida y  
Velocidad a tus  
Creaciones



[www.rasti.com.ar](http://www.rasti.com.ar)